



4D SYSTEMS
TURNING TECHNOLOGY INTO ART

PICASO Processor
Embedded Graphics Processor

DATASHEET

Document Date: 15th January 2013
Document Revision: 1.1

Contents

1. Description	3
2. Features	3
3. Applications	4
4. Pin Configuration and Summary	5
5. Pin Description	8
5.1. Display Interface	8
5.2. SPI Interface – Memory Card	9
5.3. Serial Ports - COM0, COM1 UARTS	9
5.4. Audio Interface.....	10
5.5. Touch Screen Interface	10
5.6. GPIO - General Purpose IO	10
5.7. System Pins	11
6. 4DGL - Software Language	12
7. In Circuit Serial Programming ICSP	12
8. PICASO Architecture	13
9. System Registers Memory Map	14
10. Memory Cards - FAT16 Format	16
11. Hardware Tools	16
11.1. 4D Programming Cable	16
11.2. Evaluation Display Modules	16
12. 4D Systems - Workshop 4 IDE	17
12.1. Workshop 4 – Designer Environment	17
12.2. Workshop 4 – ViSi Environment.....	17
12.3. Workshop 4 – ViSi Genie Environment	18
12.4. Workshop 4 – Serial Environment.....	18
13. Reference Design	19
14. Package Details	20
15. PCB Land Pattern	21
16. Specifications and Ratings	22
17. Legal Notice	23
18. Contact Information	23

1. Description

The PICASO Processor is a custom embedded 4DGL graphics controller designed to interface with many popular OLED and LCD display panels. Powerful graphics, text, image, animation and countless more features are built right inside the chip. It offers a simple plug-n-play interface to many 16-bit 80-Series colour LCD and OLED displays.

The chip is designed to work with minimal design effort and all of the data and control signals are provided by the chip to interface directly to the display. Simply choose your display and interface it to the PICASO on your application board. This offers enormous advantage to the designer in development time and cost saving and takes away all of the burden of low level design.

The PICASO belongs to a family of processors powered by a highly optimised soft core virtual engine, EVE (Extensible Virtual Engine). EVE is a proprietary, high performance virtual processor with an extensive byte-code instruction set optimised to execute compiled 4DGL programs. 4DGL (4D Graphics Language) was specifically developed from ground up for the EVE engine core. It is a high level language which is easy to learn and simple to understand yet powerful enough to tackle many embedded graphics applications.

The device offers modest but comprehensive I/O features and can interface to I2C, serial, digital, buttons, joystick and many more. Provision is also made for a dedicated PWM audio output that supports audio WAV files and complex sound generation.

All of the display built-in driver libraries implement and share the same high-level function interface. This allows your GUI application to be portable to different display controller types.

4D Systems software development IDE called Workshop 4 is FREE and there are no licensing requirements.

The PICASO Processor offers one of the most flexible embedded graphics solutions available.

2. Features

- Low-cost OLED, LCD and TFT display graphics user interface solution.
- Ideal as a standalone embedded graphics processor or interface to any host controller as a graphics co-processor.
- Connect to any colour display that supports an 80-Series 16 bit wide CPU interface. All data and control signals are provided.
- Built in high performance virtual processor core (EVE) with an extensive byte-code instruction set optimised for 4DGL, the high level 4D Graphics Language.
- Comprehensive set of built in graphics and multimedia services.
- Display full colour images, animations, icons and video clips.
- 14KB of Flash memory for user code storage and 14KB of SRAM for user variables.
- 13 Digital I/O pins.
- I2C interface (Master).
- D0....D15, RD, WR, RS, CS – Display interface
- FAT16 file services.
- 2 Asynchronous hardware serial ports with Auto-Baud feature.
- SPI interface support for SDHC/SD memory card for multimedia storage and data logging purposes (micro-SD with up to 2GB and SDHC memory cards starting from 4GB and above).
- 4-Wire Resistive Touch panel interface.
- Audio support for wave files and complex sound generation with a dedicated 16-bit PWM audio output.
- 8 x 16 bit timers with 1 millisecond resolution.
- Single 3.3 Volt Supply @25mA typical.
- Available in a 64 pin TQFP 10mm x 10mm package.
- RoHS compliant.

3. Applications

- General purposes embedded graphics.
- Elevator control systems.
- Point of sale terminals.
- Electronic gauges and metres.
- Test and measurement and general purpose instrumentation.
- Industrial control and Robotics.
- Automotive system displays.
- GPS navigation systems.
- Medical Instruments and applications.
- Home appliances and Smart Home Automation.
- Security and Access control systems.
- Gaming equipment..
- Aviation systems.
- HMI with touch panels.

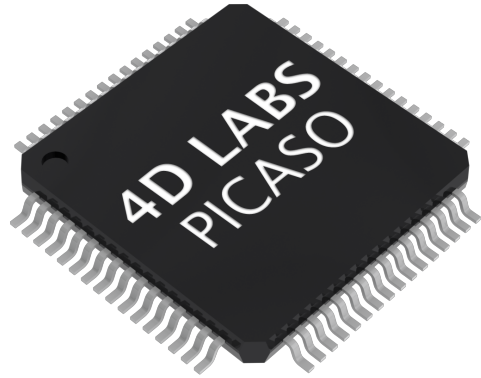

4. Pin Configuration and Summary

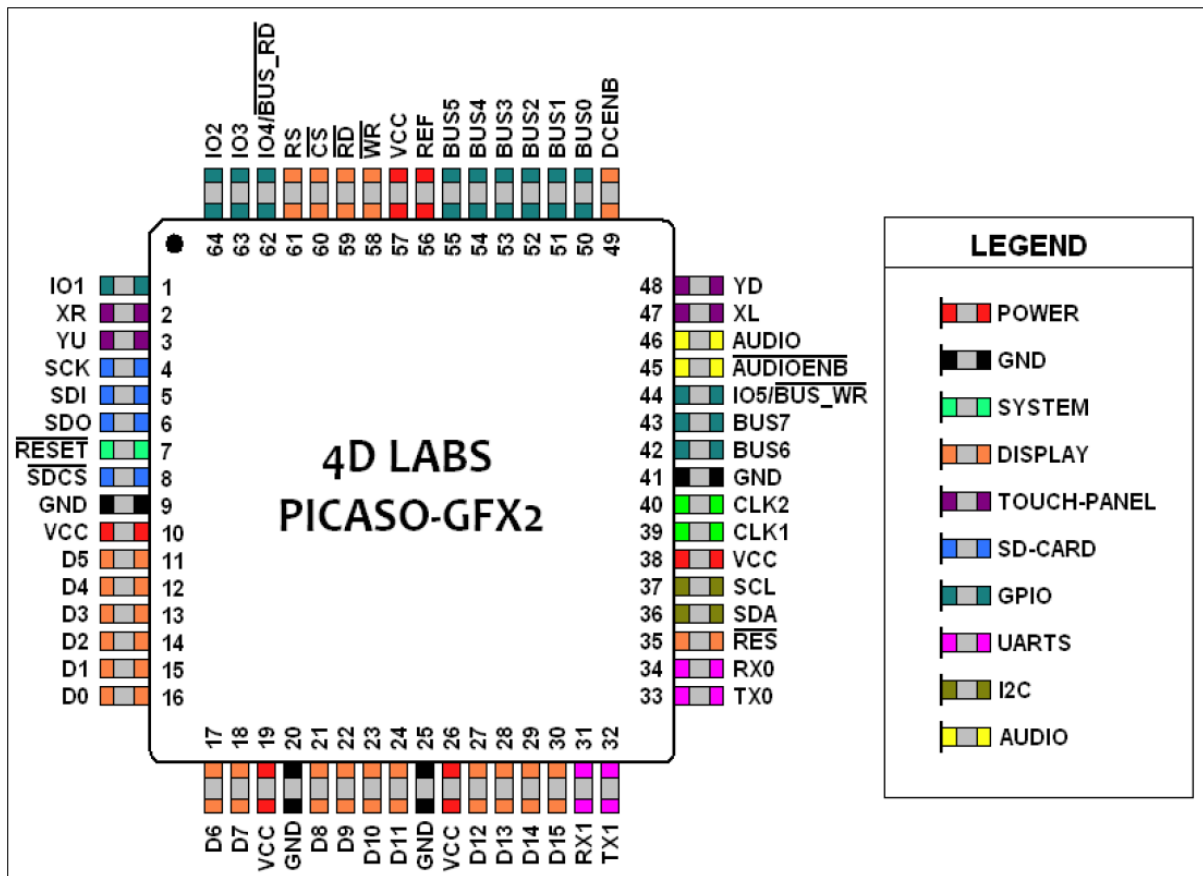

PICASO Processor Pin Out			
Pin	Symbol	I/O	Description
1	IO1	I/O	General Purpose IO1 pin. This pin is 5.0V tolerant.
2	XR	A	4-Wire Resistive Touch Screen Right signal. Connect this pin to XR or X+ signal of the touch panel.
3	YU	A	4-Wire Resistive Touch Screen Up signal. Connect this pin to YU or Y+ signal of the touch panel.
4	SCK	O	SPI Serial Clock output. SD memory card use only. Connect this pin to the SPI Serial Clock (SCK) signal of the memory card.
5	SDI	I	SPI Serial Data Input. SD memory card use only. Connect this pin to the SPI Serial Data Out (SDO) signal of the memory card.
6	SDO	O	SPI Serial Data Output. SD memory card use only. Connect this pin to the SPI Serial Data In (SDI) signal of the memory card.
7	RESET	I	Master Reset signal. Connect a 4.7K resistor from this pin to VCC.
8	SDCS	O	SD Memory-Card Chip Select. SD memory card use only. Connect this pin to the Chip Enable (CS) signal of the memory card.
9, 20, 25, 41	GND	P	Device Ground.
10, 19, 26, 38, 57	VCC	P	Device Positive Supply.

I = Input, O = Output, P = Power, A = Analogue

PICASO Processor Pin Out (continued...)			
Pin	Symbol	I/O	Description
11	D5	I/O	Display Data Bus bit 5.
12	D4	I/O	Display Data Bus bit 4.
13	D3	I/O	Display Data Bus bit 3.
14	D2	I/O	Display Data Bus bit 2.
15	D1	I/O	Display Data Bus bit1.
16	D0	I/O	Display Data Bus bit 0.
17	D6	I/O	Display Data Bus bit 6.
18	D7	I/O	Display Data Bus bit 7.
21	D8	I/O	Display Data Bus bit 8.
22	D9	I/O	Display Data Bus bit 9.
23	D10	I/O	Display Data Bus bit 10.
24	D11	I/O	Display Data Bus bit 11.
27	D12	I/O	Display Data Bus bit 12.
28	D13	I/O	Display Data Bus bit 13.
29	D14	I/O	Display Data Bus bit 14.
30	D15	I/O	Display Data Bus bit 15.
31	RX1	I	Asynchronous Serial port COM1 receive pin, RX1. Connect this pin to external serial device Transmit (Tx) signal. This pin is 5.0V tolerant.
32	TX1	O	Asynchronous Serial port COM1 transmit pin, TX1. Connect this pin to external serial device receive (Rx) signal. This pin is 5.0V tolerant.
33	TX0	O	Asynchronous Serial port Transmit pin, TX. Connect this pin to host micro-controller Serial Receive (Rx) signal. The host receives data from PICASO via this pin. This pin is 5.0V tolerant.
34	RX0	I	Asynchronous Serial port Receive pin, RX. Connect this pin to host micro-controller Serial Transmit (Tx) signal. The host transmits data to PICASO via this pin. This pin is 5.0V tolerant.
35	RES	O	Display RESET. PICASO initialises the display by strobing this pin LOW. Connect this pin to the Reset (RES) signal of the display.
36	SDA	I/O	I2C Data In/Out.
37	SCL	O	I2C Clock Output.
39	CLK1	I	Device Clock input 1 of a 12MHz crystal.
40	CLK2	O	Device Clock input 2 of a 12MHz crystal.
42	BUS6	I/O	General Purpose Parallel I/O BUS(0..7), bit 6. This pin is 5.0V tolerant.
43	BUS7	I/O	General Purpose Parallel I/O BUS(0..7), bit 7. This pin is 5.0V tolerant.
44	IO5/BUS_WR	I/O	General Purpose IO5 pin. Also used for BUS_WR signal to write and latch the data to the parallel GPIO BUS(0..7).
45	AUDENB	O	Audio Enable. Connect this pin to amplifier control. LOW: Enable external Audio amplifier. HIGH : Disable external Audio amplifier.
46	AUDIO	O	Pulse Width Modulated (PWM) Audio output. Connect this pin to a 2 stage low pass filter then into an audio amplifier.
47	XL	O	4-Wire Resistive Touch Screen Left signal. Connect this pin to XL or X- signal of the touch panel.
48	YD	O	4-Wire resistive touch screen bottom signal. Connect this pin to YD or Y- signal of the touch panel.
49	DCENB	O	DC-DC high voltage enable signal. This maybe the high voltage that drives the LCD backlight or the OLED panel supply. High: Enable DC-DC converter. Low : Disable DC-DC converter.
50	BUS0	I/O	General Purpose Parallel I/O BUS(0..7), bit 0. This pin is 5.0V tolerant.
51	BUS1	I/O	General Purpose Parallel I/O BUS(0..7), bit 1. This pin is 5.0V tolerant.

I = Input, O = Output, P = Power, A = Analogue

PICASO Processor Pin Out (continued...)			
Pin	Symbol	I/O	Description
52	BUS2	I/O	General Purpose Parallel I/O BUS(0..7), bit 2. This pin is 5.0V tolerant.
53	BUS3	I/O	General Purpose Parallel I/O BUS(0..7), bit 3. This pin is 5.0V tolerant.
54	BUS4	I/O	General Purpose Parallel I/O BUS(0..7), bit 4. This pin is 5.0V tolerant.
55	BUS5	I/O	General Purpose Parallel I/O BUS(0..7), bit 5. This pin is 5.0V tolerant.
56	REF	P	Internal voltage regulator filter capacitor. Connect a 4.7uF to 10uF capacitor from this pin to Ground.
58	WR	O	Display Write strobe signal. PICASO asserts this signal LOW when writing data to the display. Connect this pin to the Write (WR) signal of the display.
59	RD		Display Read strobe signal. PICASO asserts this signal LOW when reading data from the display. Connect this pin to the Read (RD) signal of the display.
60	CS	O	Display Chip Select. PICASO asserts this signal LOW when accessing the display. Connect this pin to the Chip Select (CS) signal of the display.
61	RS	O	Display Register Select. LOW: Display index or status register is selected. HIGH: Display GRAM or register data is selected. Connect this pin to the Register Select (RS or A0 or C/D or similar naming convention) signal of the display.
62	IO4/BUS_RD	I/O	General Purpose IO4 pin. Also used for BUS_RD signal to read and latch the data in to the parallel GPIO BUS(0..7).
63	IO3	I/O	General Purpose IO3 pin. This pin is 5.0V tolerant.
64	IO2	I/O	General Purpose IO2 pin. This pin is 5.0V tolerant.

I = Input, O = Output, P = Power, A = Analogue

5. Pin Description

The PICASO Processor provides both a hardware and a software interface. This section describes in detail the hardware interface pins of the device.

5.1. Display Interface

The PICASO supports LCD and OLED displays with an 80-Series 16-bit wide CPU data interface. The connectivity to the display is easy and straight forward. The PICASO generates all of the necessary timing to drive the display.

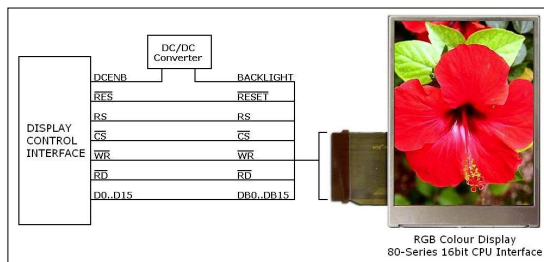

CS	RS	RD	WR	Operation
0	0	0	1	Read Display Status Register
0	0	1	0	Write Display Index Register
0	1	0	1	Read Display GRAM Data
0	1	1	0	Write Register or GRAM Data
1	X	X	X	No Operation

Display Operation Table

D0-D15 pins (Display Data Bus):

The Display Data Bus (D0-D15) is a 16-bit bidirectional port and all display data writes and reads occur over this bus. Other control signals such as RW, RD CS, and RS synchronise the data transfer to and from the display.

CS pin (Display Chip Select):

The access to the display is only possible when the Display Chip Select (CS) is asserted LOW. Connect this pin to the Chip Select (CS) signal of the display.

RS pin (Display Register Select):

The RS signal determines whether a register command or data is sent to the display.

LOW: Display index or status register is selected.

HIGH: Display GRAM or register data is selected.

Connect this pin to the Register Select (RS) signal of the display. Different displays utilise various naming conventions such as RS, A0, C/D or similar. Be sure to check with your display manufacturer for the correct name and function.

RES pin (Display Reset):

Display RESET. PICASO initialises the display by strobing this pin LOW. Connect this pin to the Reset (RES) signal of the display.

DCENB pin (External DC/DC Enable):

DC-DC high voltage enable signal. This maybe the high voltage that drives the LCD backlight or the OLED panel supply.

WR pin (Display Write):

This is the display write strobe signal. The PICASO asserts this signal LOW when writing data to the display in conjunction with the display data bus (D0-D15). Connect this pin to the Write (WR) signal of the display.

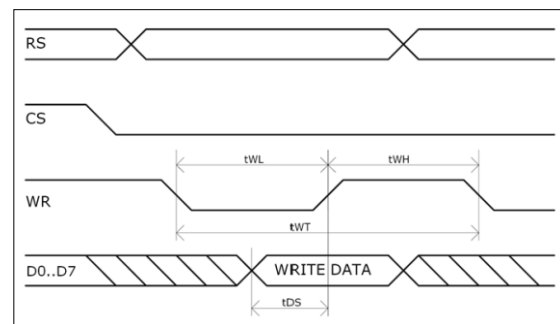

Item	Sym	Min	Typ	Max	Unit
Write Low Pulse	tWL	50	-	-	ns
Write High Pulse	tWH	50	-	-	ns
Write Bus Cycle Total	tWT	100	-	-	ns
Write Data Setup	tDS	25	-	-	ns

RD pin (Display Read):

This is the display read strobe signal. The PICASO asserts this signal LOW when reading data from the display in conjunction with the display data bus (D0-D15). Connect this pin to the Read (RD) signal of the display.

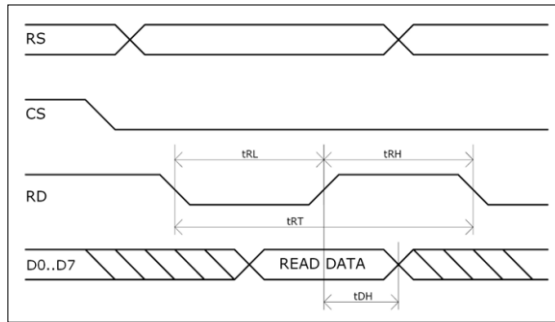

Item	Sym	Min	Typ	Max	Unit
Read Low Pulse	tRL	150	-	-	ns
Read High Pulse	tRH	150	-	-	ns
Read Bus Cycle Total	tRT	300	-	-	ns
Read Data Hold	tDH	75	-	-	ns

5.2. SPI Interface – Memory Card

The PICASO supports SD, micro-SD and MMC memory cards via its hardware SPI interface. The memory card is used for all multimedia file retrieval such as images, animations and movie clips and the SPI interface is dedicated for this purpose only. The memory card can also be used as general purpose storage for data logging applications (RAW and FAT16 format support). Support is available for micro-SD with up to 2GB capacity and for high capacity HC memory cards starting from 4GB and above.

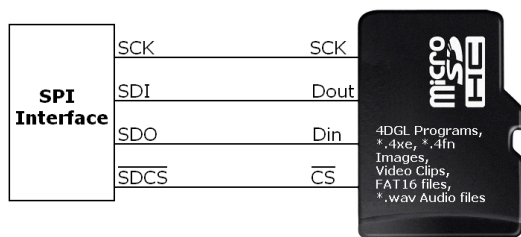

SDI pin (SPI Serial Data In):

The SPI Serial Data Input (SDI). SD memory card use only. Connect this pin to the SPI Serial Data Out (SDO) signal of the memory card.

SDO pin (SPI Serial Data Out):

The SPI Serial Data Output (SDI). SD memory card use only. Connect this pin to the SPI Serial Data In (SDI) signal of the memory card.

SCK pin (SPI Serial Clock):

The SPI Serial Clock output (SCK). SD memory card use only. Connect this pin to the SPI Serial Clock (SCK) signal of the memory card.

SDCS pin (SD Memory Card Chip Select):

SD Memory-Card Chip Select (SDCS). SD memory card use only. Connect this pin to the Chip Enable (CS) signal of the memory card.

5.3. Serial Ports - COM0, COM1 UARTS

The PICASO Processor has two dedicated hardware Asynchronous Serial ports that can communicate with external serial devices. These are referred to as the COM0 and the COM1 serial ports.

The primary features are:

- Full-Duplex 8 bit data transmission and reception.
- Data format: 8 bits, No Parity, 1 Stop bit.
- Independent Baud rates from 300 baud up to 256K baud.
- Single byte transmits and receives or a fully buffered service. The buffered service feature runs in the background capturing and buffering serial data without the user application having to constantly poll any of the serial ports. This frees up the application to service other tasks.

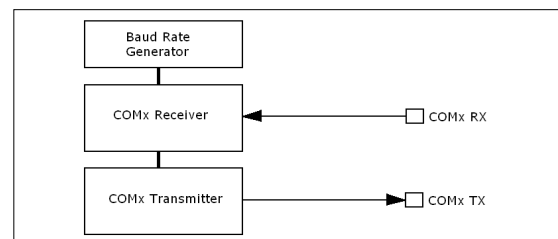

A single byte serial transmission consists of the start bit, 8-bits of data followed by the stop bit. The start bit is always 0, while a stop bit is always 1. The LSB (Least Significant Bit, Bit 0) is sent out first following the start bit. Figure below shows a single byte transmission timing diagram.

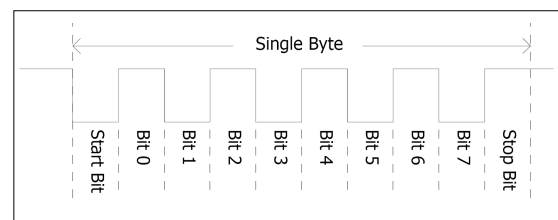

COM0 is also the primary interface for 4DGL user program downloads and chip configuration PmmC programming. Once the compiled 4DGL application program (EVE byte-code) is downloaded and the user code starts executing, the serial port is then available to the user application. Refer to Section 7. In-Circuit-Serial-

Programming (ICSP) for more details on PmmC/Firmware programming.

TX0 pin (Serial Transmit COM0):

Asynchronous Serial port COM0 transmit pin, TX0. Connect this pin to external serial device receive (Rx) signal. This pin is 5.0V tolerant.

RX0 pin (Serial Receive COM0):

Asynchronous Serial port COM0 receive pin, RX0. Connect this pin to external serial device transmit (Tx) signal. This pin is 5.0V tolerant.

TX1 pin (Serial Transmit COM1):

Asynchronous Serial port COM1 transmit pin, TX1. Connect this pin to external serial device receive (Rx) signal. This pin is 5.0V tolerant.

RX1 pin (Serial Receive COM1):

Asynchronous Serial port COM1 receive pin, RX1. Connect this pin to external serial device transmit (Tx) signal. This pin is 5.0V tolerant.

5.4. Audio Interface

The exclusive audio support in the PICASO Processor makes it better than its peers in the Graphics processor range. PWM ensures better sound quality with a volume range of 8 to 127. A simple instruction empowers the user to execute the audio files. Audio operation can be carried out simultaneously with the execution of other necessary instructions.

For a complete list of audio commands please refer to the separate document titled '[PICASO-4DGL-Internal-Functions.pdf](#)'.

AUDIO pin (Audio PWM output):

External Amplifier Output pin. This pin provides a 16-bit DAC/PWM audio output to use with an external audio amplifier. Example circuit below provides a low cost implementation. If unused then this pin must be left open or floating.

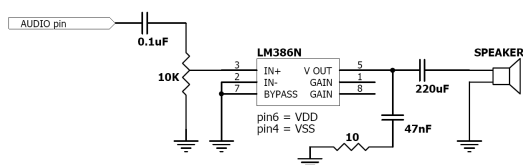

Optional Power Audio Circuit

AUDENB pin (Audio Enable output):

External Amplifier enable pin. This pin provides ON/OFF amplifier control. If unused then this pin must be left open or floating.

LOW: Enable external Audio amplifier.

HIGH : Disable external Audio amplifier.

5.5. Touch Screen Interface

The PICASO supports 4-Wire resistive touch panels. The diagram below shows a simplified interface between the PICASO and a touch panel.

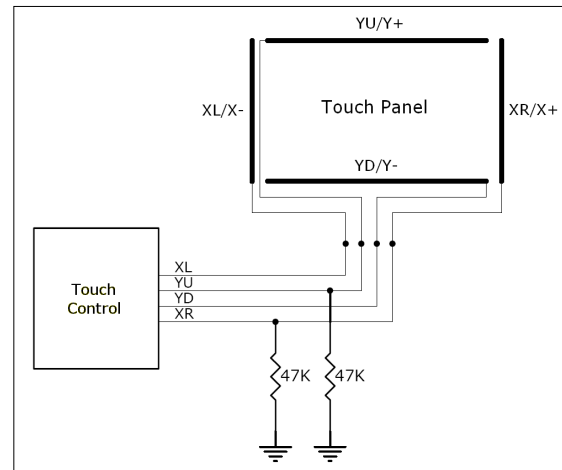

XR pin (Touch Panel X-Read input):

4-Wire Resistive Touch Screen X-Read analog signal. Connect this pin to XR or X+ signal of the touch panel.

XL pin (Touch Panel X-Drive output):

4-Wire Resistive Touch Screen X Drive signal. Connect this pin to XL or X- signal of the touch panel.

YU pin (Touch Panel Y-Read input):

4-Wire Resistive Touch Screen Y-Read analog signal. Connect this pin to YU or Y+ signal of the touch panel.

YD pin (Touch Panel Y-Drive output):

4-Wire Resistive Touch Screen Y Drive signal. Connect this pin to YD or Y- signal of the touch panel.

5.6. GPIO - General Purpose IO

There are 13 general purpose Input/Output (GPIO) pins available to the user. These are grouped as IO1..IO5 and BUS0..BUS7. The 5 I/O pins (IO1..IO5), provide flexibility of individual bit operations while the 8 pins (BUS0..BUS7), known as GPIO BUS, serve collectively for byte wise operations. The IO4 and IO5 also act as strobing signals to control the GPIO Bus. GPIO Bus can be read or written by strobing a low pulse (50 nsec duration or greater)

the IO4/BUS_RD or IO5/BUS_WR for read or write respectively. For detailed usage refer to the separate document titled:

'[PICASO-4DGL-Internal-Functions.pdf](#)'.

IO1-IO3 pins (3 x GPIO pins):

General purpose I/O pins. Each pin can be individually set for INPUT or an OUTPUT. Power-Up Reset default is all INPUTS.

IO4/BUS_RD pin (GPIO IO4 or BUS_RD pin):

General Purpose IO4 pin. Also used for BUS_RD signal to read and latch the data in to the parallel GPIO BUS0..BUS7.

IO5/BUS_WR pin (GPIO IO5 or BUS_WR pin):

General Purpose IO5 pin. Also used for BUS_WR signal to write and latch the data to the parallel GPIO BUS0..BUS7.

BUS0-BUS7 pins (GPIO 8-Bit Bus):

8-bit parallel General purpose I/O Bus.

Note: All GPIO pins are 5.0V tolerant.

5.7. System Pins

VCC pins (Device Supply Voltage):

Device supply voltage pins. These pins must be connected to a regulated supply voltage in the range of 3.0 Volts to 3.6 Volts DC. Nominal operating voltage is 3.3 Volts.

GND pins (Device Ground):

Device ground pins. These pins must be connected to system ground.

RESET pin (Device Master Reset):

Device Master Reset pin. An active low pulse of greater than 2 micro-seconds will reset the device. Connect a resistor (1K through to 10K, nominal 4.7K) from this pin to VCC. Only use open collector type circuits to reset the device if an external reset is required. This pin is not driven low by any internal conditions.

CLK1, CLK2 pins (Device Oscillator Inputs):

CLK1 and CLK2 are the device oscillator pins. Connect a 12MHz AT strip cut crystal with 22pF capacitors from each pin to GND as shown in the diagram below.

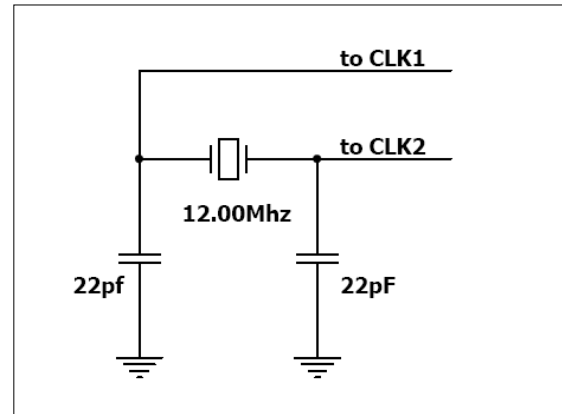

6. 4DGL - Software Language

The PICASO processor belongs to a family of processors powered by a highly optimised soft core virtual engine, EVE (Extensible Virtual Engine).

EVE is a proprietary, high performance virtual-machine with an extensive byte-code instruction set optimised to execute compiled 4DGL programs. 4DGL (4D Graphics Language) was specifically developed from ground up for the EVE engine core. It is a high level language which is easy to learn and simple to understand yet powerful enough to tackle many embedded graphics applications.

4DGL is a graphics oriented language allowing rapid application development, and the syntax structure was designed using elements of popular languages such as C, Basic, Pascal and others.

Programmers familiar with these languages will feel right at home with 4DGL. It includes many familiar instructions such as IF..ELSE..ENDIF, WHILE..WEND, REPEAT..UNTIL, GOSUB..ENDSUB, GOTO, PRINT as well as some specialised instructions SERIN, SEROUT, GFX_LINE, GFX_CIRCLE and many more.

For detailed information pertaining to the 4DGL language, please refer to the following documents:
"4DGL-Programmers-Reference-Manual.pdf"
"PICASO-4DGL-Internal-Functions.pdf"

To assist with the development of 4DGL applications, the Workshop 4 IDE combines a full-featured editor, a compiler, a linker and a downloader into a single PC-based application. It's all you need to code, test and run your applications.

7. In Circuit Serial Programming ICSP

The PICASO processor is a custom graphics processor. All functionality including the high level commands are built into the chip. This chip level configuration is available as a Firmware/PmmC (Personality-module-micro-Code) file.

A PmmC file contains all of the low level micro-code information (analogy of that of a soft silicon) which define the characteristics and functionality of the device. The ability of programming the device with a PmmC file provides an extremely flexible method of customising as well as upgrading it with future enhancements.

A PmmC file can only be programmed into the device via its COM0 serial port and an access to this must be provided for on the target application board. This is referred to as In Circuit Serial Programming (ICSP). Figure below provides a typical implementation for the ICSP interface.

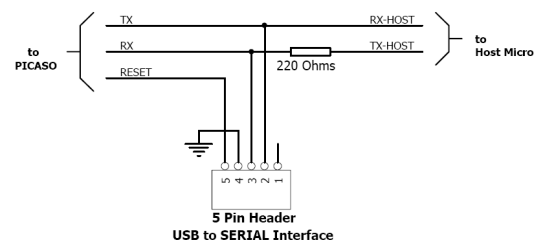

The PmmC file is programmed into the device with the aid of Workshop 4, the 4D Systems IDE software (See Section 12). To provide a link between the PC and the ICSP interface, a specific 4D Programming Cable is required and is available from 4D Systems.

Using a non-4D programming interface could damage your processor, and **void your Warranty.**

Note: The PICASO processor is shipped blank and it must be programmed with the PmmC configuration file.

8. PICASO Architecture

The figure below illustrates the PICASO Processors architecture.

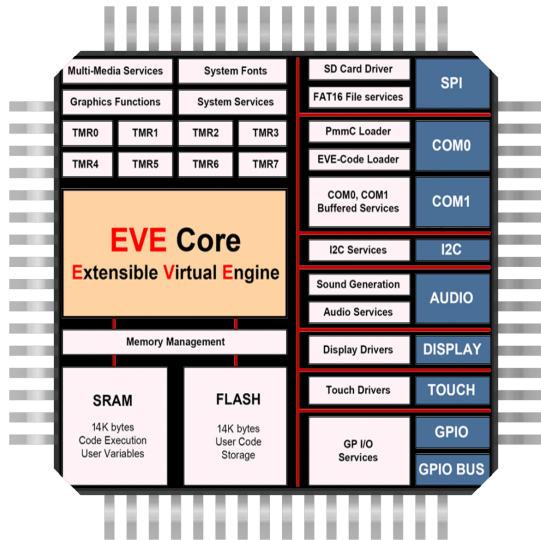

9. System Registers Memory Map

The following tables outline in detail the PICASO system registers and flags.

PICASO System Registers and Flags			
LABEL	ADDRESS		USAGE
	DEC	HEX	
RANDOM_LO	32	0x20	random generator LO word
RANDOM_HI	33	0x21	random generator HI word
SYSTEM_TIMER_LO	34	0x22	1msec system timer LO word
SYSTEM_TIMER_HI	35	0x23	1msec system timer HI word
TIMER0	36	0x24	1msec user timer 0
TIMER1	37	0x25	1msec user timer 1
TIMER2	38	0x26	1msec user timer 2
TIMER3	39	0x27	1msec user timer 3
TIMER4	40	0x28	1msec user timer 3
TIMER5	41	0x29	1msec user timer 3
TIMER6	42	0x2A	1msec user timer 3
TIMER7	43	0x2B	1msec user timer 3
SYS_X_MAX	44	0x2C	display hardware X res-1
SYS_Y_MAX	45	0x2D	display hardware Y res-1
GFX_XMAX	46	0x2E	width of current orientation
GFX_YMAX	47	0x2F	height of current orientation
GFX_LEFT	48	0x30	image left real point
GFX_TOP	49	0x31	image top real point
GFX_RIGHT	50	0x32	image right real point
GFX_BOTTOM	51	0x33	image bottom real point
GFX_X1	52	0x34	image left clipped point
GFX_Y1	53	0x35	image top clipped point
GFX_X2	54	0x36	image right clipped point
GFX_Y2	55	0x37	image bottom clipped point
GFX_X_ORG	56	0x38	current X origin
GFX_Y_ORG	57	0x39	current Y origin
GFX_HILITE_LINE	58	0x3A	current multi line button hilite line
GFX_LINE_COUNT	59	0x3B	count of lines in multiline button
GFX_LAST_SELECTION	60	0x3C	Last selected line
GFX_HILIGHT_BACKGROUND	61	0x3D	multi button hilite background colour
GFX_HILIGHT_FOREGROUND	62	0x3E	multi button hilite background colour
GFX_BUTTON_FOREGROUND	63	0x3F	store default text colour for hilite line tracker
GFX_BUTTON_BACKGROUND	64	0x40	store default button colour for hilite line tracker
GFX_BUTTON_MODE	65	0x41	store current buttons mode
GFX_TOOLBAR_HEIGHT	66	0x42	height above
GFX_STATUSBAR_HEIGHT	67	0x43	height below
GFX_LEFT_GUTTER_WIDTH	68	0x44	width to left
GFX_RIGHT_GUTTER_WIDTH	69	0x45	width to right
GFX_PIXEL_SHIFT	70	0x46	pixel shift for button depress illusion
GFX_VECT_X1	71	0x47	gp rect, used by multiline button to hilite required line

PICASO System Registers and Flags (continued...)			
LABEL	ADDRESS		USAGE
	DEC	HEX	
GFX_VECT_Y1	72	0x48	
GFX_VECT_X2	73	0x49	
GFX_VECT_Y2	74	0x4A	
GFX_THUMB_PERCENT	75	0x4B	size of slider thumb as percentage
GFX_THUMB_BORDER_DARK	76	0x4C	darker shadow of thumb
GFX_THUMB_BORDER_LIGHT	77	0x4D	lighter shadow of thumb
TOUCH_XMINCAL	78	0x4E	touch calibration value
TOUCH_YMINCAL	79	0x4F	touch calibration value
TOUCH_XMAXCAL	80	0x50	touch calibration value
TOUCH_YMAXCAL	81	0x51	touch calibration value
IMG_WIDTH	82	0x52	width of currently loaded image
IMG_HEIGHT	83	0x53	height of currently loaded image
IMG_FRAME_DELAY	84	0x54	if image, else inter frame delay for movie
IMG_FLAGS	85	0x55	bit 4 determines colour mode, other bits reserved
IMG_FRAME_COUNT	86	0x56	count of frames in a movie
IMG_PIXEL_COUNT_LO	87	0x57	count of pixels in the current frame
IMG_PIXEL_COUNT_HI	88	0x58	count of pixels in the current frame
IMG_CURRENT_FRAME	89	0x59	last frame shown
MEDIA_ADDRESS_LO	90	0x5A	micro-SD byte address LO
MEDIA_ADDRESS_HI	91	0x5B	micro-SD byte address HI
MEDIA_SECTOR_LO	92	0x5C	micro-SD sector address LO
MEDIA_SECTOR_HI	93	0x5D	micro-SD sector address HI
MEDIA_SECTOR_COUNT	94	0x5E	micro-SD number of bytes remaining in sector
TEXT_XPOS	95	0x5F	text current x pixel position
TEXT_YPOS	96	0x60	text current y pixel position
TEXT_MARGIN	97	0x61	text left pixel pos for carriage return
TXT_FONT_TYPE	98	0x62	font type, 0 = system font, else pointer to user font
TXT_FONT_MAX	99	0x63	max number of chars in font
TXT_FONT_OFFSET	100	0x64	starting offset (normally 0x20)
TXT_FONT_WIDTH	101	0x65	current font width
TXT_FONT_HEIGHT	102	0x66	Current font height
GFX_TOUCH_REGION_X1	103	0x67	touch capture region
GFX_TOUCH_REGION_Y	104	0x68	
GFX_TOUCH_REGION_X2	105	0x69	
GFX_TOUCH_REGION_Y2	106	0x6A	
GFX_CLIP_LEFT_VAL	107	0x6B	left clipping point (set with gfx_ClipWindow(...))
GFX_CLIP_TOP_VAL	108	0x6C	top clipping point (set with gfx_ClipWindow(...))
GFX_CLIP_RIGHT_VAL	109	0x6D	right clipping point (set with gfx_ClipWindow(...))
GFX_CLIP_BOTTOM_VAL	110	0x6E	bottom clipping point (set with gfx_ClipWindow(...))
GFX_CLIP_LEFT	111	0x6F	current clip value (reads full size if clipping turned off)
GFX_CLIP_TOP	112	0x70	current clip value (reads full size if clipping turned off)
GFX_CLIP_RIGHT	113	0x71	current clip value (reads full size if clipping turned off)
GFX_CLIP_BOTTOM	114	0x72	current clip value (reads full size if clipping turned off)
GRAM_PIXEL_COUNT_LO	115	0x73	LO word of count of pixels in the set GRAM area
GRAM_PIXEL_COUNT_HI	116	0x74	HI word of count of pixels in the set GRAM area

NOTE: These registers are accessible with [peekW](#) and [pokeW](#) functions.

10. Memory Cards - FAT16 Format

The PICASO Processor uses off the shelf standard SDHC/SD/micro-SD memory cards with up to 2GB capacity usable with FAT16 formatting. For any FAT file related operations, before the memory card can be used it must first be formatted with FAT16 option. The formatting of the card can be done on any PC system with a card reader. Select the appropriate drive and choose the FAT16 (or just FAT in some systems) option when formatting. The card is now ready to be used in the PICASO based application.



The PICASO Processor also supports high capacity HC memory cards (4GB and above). The available capacity of SD-HC cards varies according to the way the card is partitioned and the commands used to access it.

The FAT partition is always first (if it exists) and can be up to the maximum size permitted by FAT16. Windows 7 will format FAT16 up to 4GB. Windows XP will format FAT16 up to 2GB and the Windows XP command prompt will format FAT16 up to 4GB.

11. Hardware Tools

The following hardware tools are required for full control of the PICASO Processor.

11.1. 4D Programming Cable

The 4D Programming Cable is an essential hardware tool to program, customise and test the PICASO Processor.

The 4D Programming Cable is used to program a new Firmware/PmmC and downloading compiled 4DGL code into the processor. It even serves as an interface for communicating serial data to the PC.

The 4D Programming Cable is available from 4D Systems, www.4dsystems.com.au

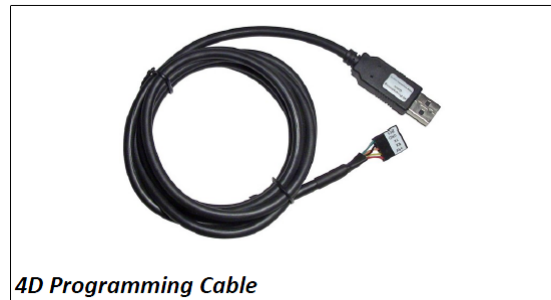

4D Programming Cable

11.2. Evaluation Display Modules

The following modules, available from 4D Systems, can be used for evaluation purposes to discover what the PICASO processor has to offer.

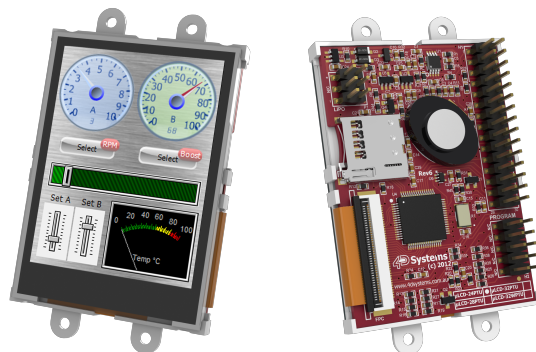

uLCD-24PTU – 2.4" Intelligent PICASO Display

Other modules, such as the 2.8", 3.2" and 3.2" Wide versions are also available. Please contact 4D Systems for more information, or visit the 4D Systems website, www.4dsystems.com.au

12. 4D Systems - Workshop 4 IDE

Workshop 4 is a comprehensive software IDE that provides an integrated software development platform for all of the 4D family of processors and modules. The IDE combines the Editor, Compiler, Linker and Down- Loader to develop complete 4DGL application code. All user application code is developed within the Workshop 4 IDE.



The Workshop 4 IDE supports multiple development environments for the user, to cater for different user requirements and skill level.

- The **Designer** environment enables the user to write 4DGL code in its natural form to program the Picaso module.
- A visual programming experience, suitably called **ViSi**, enables drag-and-drop type placement of objects to assist with 4DGL code generation and allows the user to visualise how the display will look while being developed.
- An advanced environment called **ViSi-Genie** doesn't require any 4DGL coding at all, it is all done automatically for you. Simply lay the display out with the objects you want, set the events to drive them and the code is written for you automatically. ViSi-Genie provides the latest rapid development experience from 4D Systems.
- A **Serial** environment is also provided to transform the Picaso module into a slave serial module, allowing the user to control the display from any host microcontroller or device with a serial port.

The Workshop 4 IDE is available from the 4D Systems website. www.4dsystems.com.au

For a comprehensive manual on the Workshop 4 IDE Software along with other documents, refer to the documentation from the 4D Systems website, on the Workshop 4 product page.

12.1. Workshop 4 – Designer Environment

Choose the Designer environment to write 4DGL code in its raw form.

The Designer environment provides the user with a simple yet effective programming environment where pure 4DGL code can be written, compiled and downloaded to the Picaso.

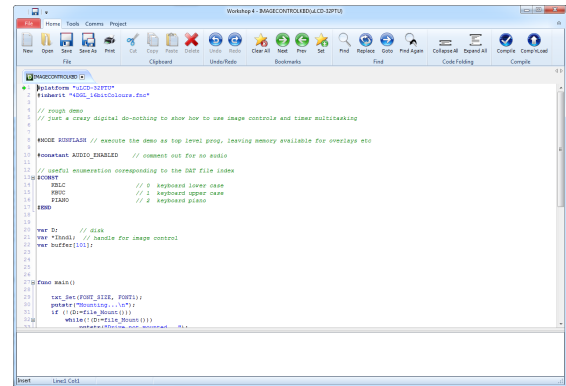

12.2. Workshop 4 – ViSi Environment

ViSi was designed to make the creation of graphical displays a more visual experience.

ViSi is a great software tool that allows the user to see the instant results of their desired graphical layout. Additionally, there is a selection of inbuilt dials, gauges and meters that can simply be placed onto the simulated module display. From here each object can have its properties edited, and at the click of a button all relevant 4DGL code associated with that object is produced in the user program. The user can then write 4DGL code around these objects to utilise them in the way they choose.

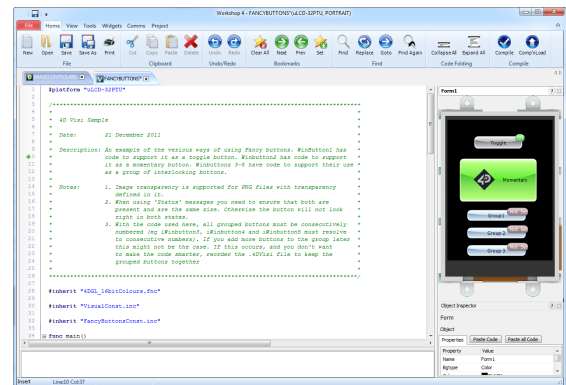

12.3. Workshop 4 – ViSi Genie Environment

ViSi Genie is a breakthrough in the way 4D Systems' graphic display modules are programmed. It is an environment like no other, a code-less programming environment that provides the user with a rapid visual experience, enabling a simple GUI application to be 'written' from scratch in literally seconds.

ViSi Genie does all the background coding, no 4DGL to learn, it does it all for you.

Pick and choose the relevant objects to place on the display, much like the ViSi Environment, yet without having to write a single line of code. Each object has parameters which can be set, and configurable events to animate and drive other objects or communicate with external devices.

Simply place an object on the screen, position and size it to suit, set the parameters such as colour, range, text, and finally select the event you wish the object to be associated with, it is that simple.

In seconds you can transform a blank display into a fully animated GUI with moving sliders, animated press and release buttons, and much more. All without writing a single line of code!

ViSi Genie provides the user with a feature rich rapid development environment, second to none.

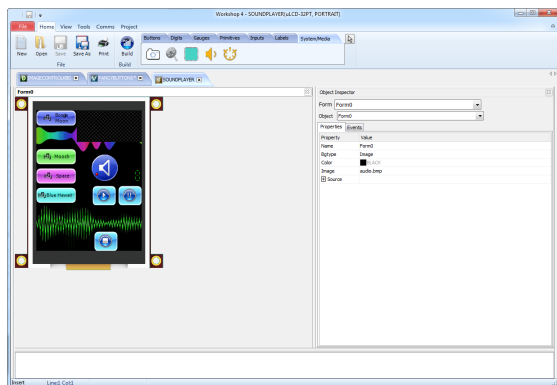

12.4. Workshop 4 – Serial Environment

The Serial environment in the Workshop 4 IDE provides the user the ability to transform the Picaso into a slave serial graphics controller.

This enables the user to use their favourite microcontroller or serial device as the Host, without having to learn 4DGL or program in a separate IDE. Once the Picaso is configured and downloaded to from the Serial Environment,

simple graphic commands can be sent from the users host microcontroller to display primitives, images, sound or even video.

Refer to the “**Serial Command Set Reference Manual**” from the Workshop 4 product page on the 4D Systems website for a complete listing of all the supported serial commands

By default, each module shipped from the 4D Systems factory will come pre-programmed ready for use in the Serial mode.

13. Reference Design

PICASO PROCESSOR

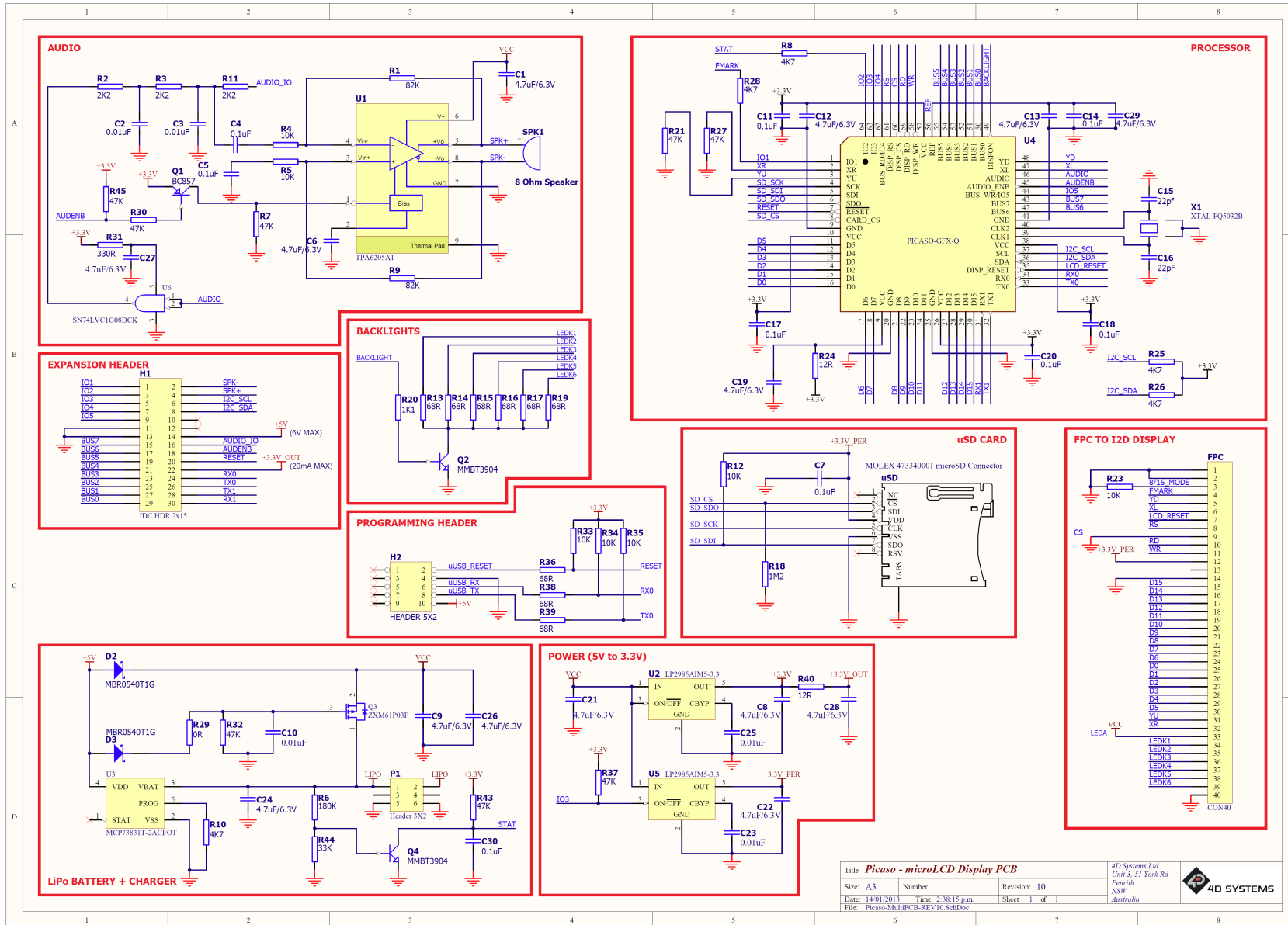

Title: Picaso - microLCD Display PCB		4D Systems Ltd Unit 3, 51 York Rd Penrith NSW Australia	
Size: A3	Number:	Revision: 10	4D SYSTEMS
Date: 14/01/2013	Time: 2:38:15 p.m.	Sheet: 1 of 1	
File: Picaso-MultiPCB-REV10.SchDoc			

14. Package Details

64-Lead Plastic Thin Quad Flatpack (PT) – 10x10x1 mm Body, 2.00 mm [TQFP]

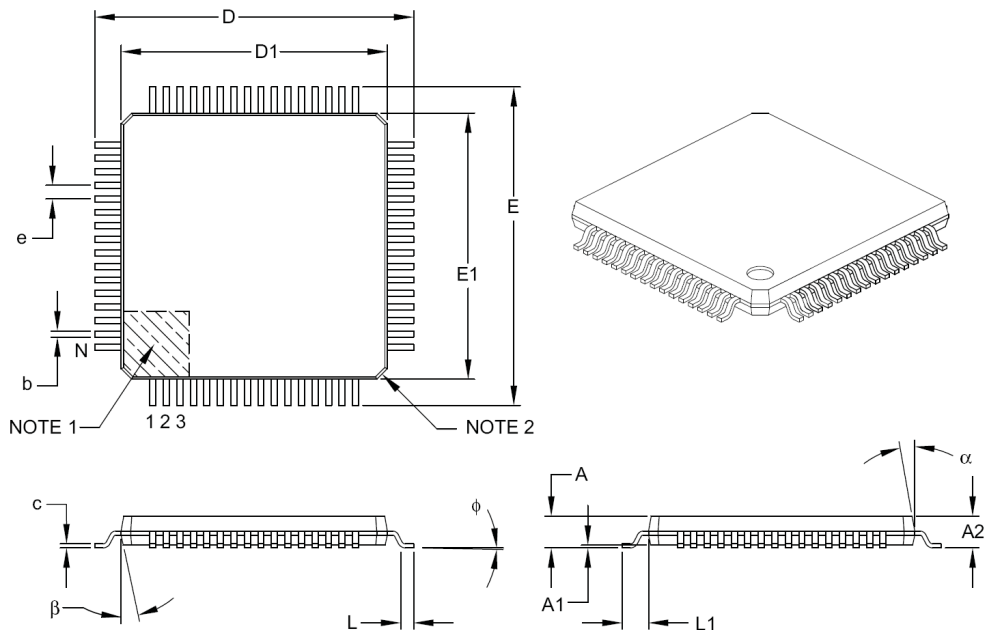

Dimension Limits	Units	MILLIMETERS		
		MIN	NOM	MAX
Number of Leads	N	64		
Lead Pitch	e	0.50 BSC		
Overall Height	A	–	–	1.20
Molded Package Thickness	A2	0.95	1.00	1.05
Standoff	A1	0.05	–	0.15
Foot Length	L	0.45	0.60	0.75
Footprint	L1	1.00 REF		
Foot Angle	ϕ	0°	3.5°	7°
Overall Width	E	12.00 BSC		
Overall Length	D	12.00 BSC		
Molded Package Width	E1	10.00 BSC		
Molded Package Length	D1	10.00 BSC		
Lead Thickness	c	0.09	–	0.20
Lead Width	b	0.17	0.22	0.27
Mold Draft Angle Top	α	11°	12°	13°
Mold Draft Angle Bottom	β	11°	12°	13°

Notes:

- Pin 1 visual index feature may vary, but must be located within the hatched area.
- Chamfers at corners are optional; size may vary.
- Dimensions D1 and E1 do not include mold flash or protrusions. Mold flash or protrusions shall not exceed 0.25 mm per side.
- Dimensioning and tolerancing per ASME Y14.5M.

BSC: Basic Dimension. Theoretically exact value shown without tolerances.

REF: Reference Dimension, usually without tolerance, for information purposes only.

15. PCB Land Pattern

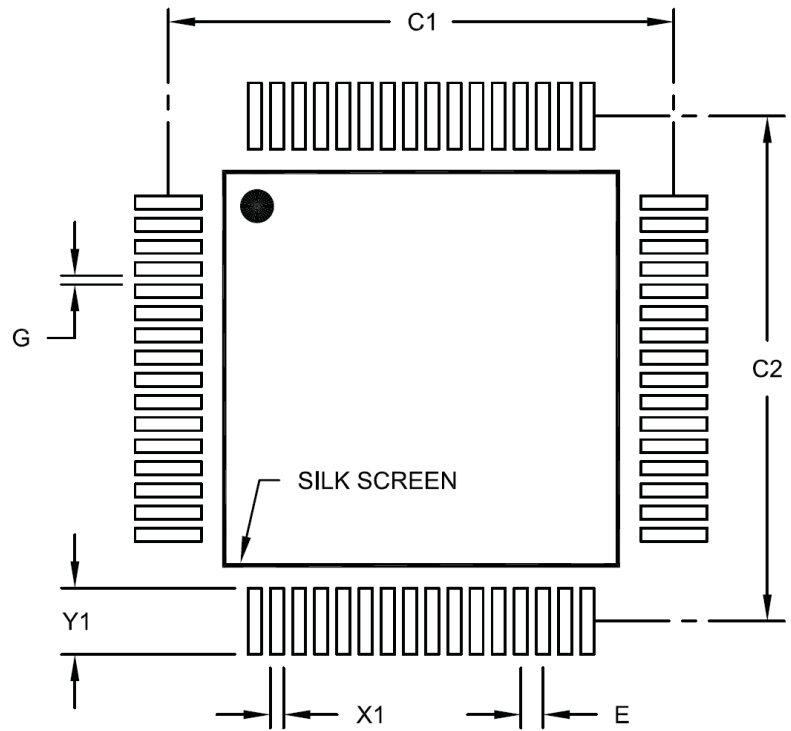

RECOMMENDED LAND PATTERN

Dimension Limits	Units	MILLIMETERS		
		MIN	NOM	MAX
Contact Pitch	E	0.50 BSC		
Contact Pad Spacing	C1		11.40	
Contact Pad Spacing	C2		11.40	
Contact Pad Width (X64)	X1			0.30
Contact Pad Length (X64)	Y1			1.50
Distance Between Pads	G	0.20		

Notes:

1. Dimensioning and tolerancing per ASME Y14.5M

BSC: Basic Dimension. Theoretically exact value shown without tolerances.

16. Specifications and Ratings

ABSOLUTE MAXIMUM RATINGS

Operating ambient temperature	-40°C to +85°C
Storage temperature	-65°C +150°C
Voltage on VCC with respect to GND	-0.3V to 4.0V
Maximum current out of GND pin	300mA
Maximum current into VCC pin	250mA
Maximum output current sunk/sourced by any pin	4.0mA
Total power dissipation	1.0W

NOTE: Stresses above those listed here may cause permanent damage to the device. This is a stress rating only and functional operation of the device at those or any other conditions above those indicated in the recommended operation listings of this specification is not implied. Exposure to maximum rating conditions for extended periods may affect device reliability.

RECOMMENDED OPERATING CONDITIONS

Parameter	Conditions	Min	Typ	Max	Units
Supply Voltage (VCC)		3.0	3.3	3.6	V
Operating Temperature		-40	--	+80	°C
External Crystal (Xtal)		--	12.00	--	Mhz
Input Low Voltage (VIL)	VCC = 3.3V, all pins	VGND	--	0.2VCC	V
Input High Voltage (VIH)	VCC = 3.3V, non 5V tolerant pins	0.8VCC	--	VCC	V
Input High Voltage (VIH)	All GPIO pins, RX0 and TX0 pins	0.8VCC	--	5.5	V

GLOBAL CHARACTERISTICS BASED ON OPERATING CONDITIONS

Parameter	Conditions	Min	Typ	Max	Units
Supply Current (ICC)	VCC = 3.3V	--	50	90	mA
Internal Operating Frequency	Xtal = 12.00Mhz	--	48.00	--	Mhz
Output Low Voltage (VOL)	VCC = 3.3V, IOL = 3.4mA	--	--	0.4	V
Output High Voltage (VOH)	VCC = 3.3V, IOL = -2.0mA	2.4	--	--	V
A/D Converter Resolution	XR, YU pins	8	--	10	bits
Capacitive Loading	CLK1, CLK2 pins	--	--	15	pF
Capacitive Loading	All other pins	--	--	50	pF
Flash Memory Endurance	PmmC Programming	--	10000	--	E/W

ORDERING INFORMATION

Order Code: PICASO

Package: TQFP-64, 10mm x 10mm

Packaging: Trays of 160 pieces

17. Legal Notice

Proprietary Information

The information contained in this document is the property of 4D Systems Pty. Ltd. and may be the subject of patents pending or granted, and must not be copied or disclosed without prior written permission.

4D Systems endeavours to ensure that the information in this document is correct and fairly stated but does not accept liability for any error or omission. The development of 4D Systems products and services is continuous and published information may not be up to date. It is important to check the current position with 4D Systems. 4D Systems reserves the right to modify, update or makes changes to Specifications or written material without prior notice at any time.

All trademarks belong to their respective owners and are recognised and acknowledged.

Disclaimer of Warranties & Limitation of Liability

4D Systems makes no warranty, either expressed or implied with respect to any product, and specifically disclaims all other warranties, including, without limitation, warranties for merchantability, non-infringement and fitness for any particular purpose.

Information contained in this publication regarding device applications and the like is provided only for your convenience and may be superseded by updates. It is your responsibility to ensure that your application meets with your specifications.

In no event shall 4D Systems be liable to the buyer or to any third party for any indirect, incidental, special, consequential, punitive or exemplary damages (including without limitation lost profits, lost savings, or loss of business opportunity) arising out of or relating to any product or service provided or to be provided by 4D Systems, or the use or inability to use the same, even if 4D Systems has been advised of the possibility of such damages.

4D Systems products are not fault tolerant nor designed, manufactured or intended for use or resale as on line control equipment in hazardous environments requiring fail – safe performance, such as in the operation of nuclear facilities, aircraft navigation or communication systems, air traffic control, direct life support machines or weapons systems in which the failure of the product could lead directly to death, personal injury or severe physical or environmental damage ('High Risk Activities'). 4D Systems and its suppliers specifically disclaim any expressed or implied warranty of fitness for High Risk Activities.

Use of 4D Systems' products and devices in 'High Risk Activities' and in any other application is entirely at the buyer's risk, and the buyer agrees to defend, indemnify and hold harmless 4D Systems from any and all damages, claims, suits, or expenses resulting from such use. No licenses are conveyed, implicitly or otherwise, under any 4D Systems intellectual property rights.

18. Contact Information

For Technical Support: support@4dsystems.com.au

For Sales Support: sales@4dsystems.com.au

Website: www.4dsystems.com.au

Copyright 4D Systems Pty. Ltd. 2000-2012.

Mouser Electronics

Authorized Distributor

Click to View Pricing, Inventory, Delivery & Lifecycle Information:

[4D Systems:](#)

[PICASO](#)